

MT 835 / MT 1135 / MT 1335

TELESCOPIC FORKLIFT TRUCKS



 **MANITOU**

www.manitou.com

MT 835 / MT 1135 / MT 1335

Your choice of 3 models



MT 835

8 m / 3.5 T



MT 1135

11 m / 3.5 T
with/without
stabilizers



MT 1335

13 m / 3.5 T





MANITOU YOUR PARTNER FOR ALL YOUR HANDLING SOLUTIONS FOR OVER 50 YEARS...

MANITOU, your partner for your needs for more than 50 years **whatever your application.**

The new telescopic forklifts represent a complete revolution in methods of lifting between 8 and 13 metres, and offer high performance lifting and loading capability:

- Standard design benefits for ease of use and maintenance
- Compact machines, maximum lift capacity
- Choice of transmission - torque convertor or hydrostatic
- Platform mode: Full range of MANITOU attachments

These forklifts are your allies in your quest for **productivity** and **simplicity.**

The **performance** and **manoeuvrability** of the new telescopic MANITOU forklift trucks let you carry out all your building and renovation tasks **quickly** and **in complete safety.**



SIMPLICITY

Simple OPERATION and MAINTENANCE

IDENTICAL OPERATING system for every model

Spacious and comfortable cab



Ergonomic control



- panel shows all the information you need - direction, wheel alignment, boom angle, fuel level, hourometer, ...
- with **state of charge monitor** adapted to three working modes - forks, bucket, jib

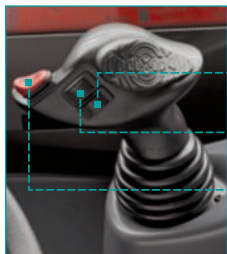

JSM® : Joystick Switch & Move

- Operating button for the attachment
- Operating button to raise or lower the telescope
- Lever for direction control - forward and reverse



You can work with SIMPLICITY and in complete SAFETY

- Platform usage: **automatic blocking of the rear point** (models MT 1135, MT 1335)
- Control of the **hydraulic flow** of the line to the attachment
- **Automatic parking brake** with starting assistance on slopes
- **EASY CONNECT SYSTEM** allowing for the hydraulic line depressurisation without stopping the engine
- **Lock of the slope of the fork face** to make your handling movements with a suspended load safer
- **Digicode** to start the machine



IDENTICAL MAINTENANCE

 whatever the model

- The engine, transmission, hydraulics, cab, frame - all are sourced from the same design.
- **2-sided opening of the engine compartment** - no need to undo any parts, thereby saving maintenance time.

FULL 360° DEGREE VISIBILITY



SAFE AND RAPID ACCESS

through a wide door with a single notched anti-slip step.

MAINTENANCE and **DIAGNOSTICS** for the machine shown on **multi-function screen** on the dashboard.

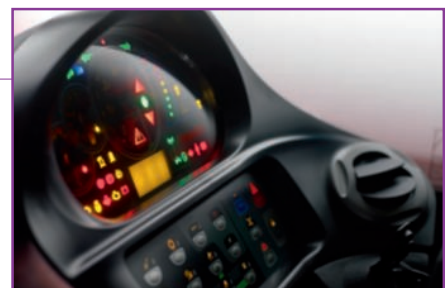

PRODUCTIVITY

PERFORMANCE and MAINTENANCE

102 HP

permanent four-wheel drive
New generation **STAGE 3B**
engine with particle filter.

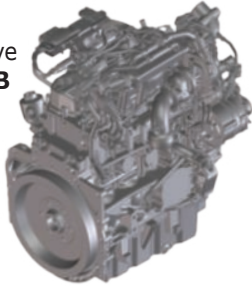

According to your needs

hydrostatic transmission or **torque converter** (inching an optional extra) to respond to your working practice.

Permanent 4 wheel drive

Powerful braking applied on both axles.



Substantial ground clearance

41 cm

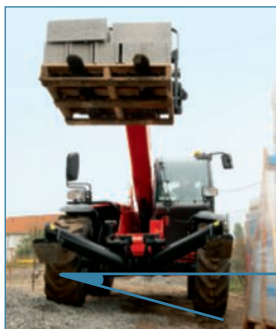

3 lifting heights

8 - 11 - 13 m

One nominal load capacity

3.5 T

Frame Levelling

(standard on MT 1135 and MT 1335) **+/- 10°**



Compact stabilizers

(MT 1135 and MT 1335)

which remain within the working width of the machine whatever their position.

Ultra-short turning radius

3.85 m



3 Steering modes



4 steering wheels for short turning spaces on restricted sites



2 front driving wheels to guarantee on-road safety



Crabwise movement for lateral approaches and delicate exits

Your MANITOU forklift, a **multi purpose** machine...





Thanks to the MANITOU **attachment system**, you can **easily and quickly fit numerous attachments to your forklift** - forks, buckets, mixers, jibs, platform...





...for a **multitude of applications**

Versatility of MANITOU forklifts answers all **your on-site needs**, making the most of your working time and productivity:

- placing of loads
- distribution of material in restricted space
- bulk loading at depots and on-site
- placing suspended loads
- lifting personnel...

LOAD PLACING				
Forks	Hook Jib	Lattice Jib	Extensible Lattice Jib	Winch
				

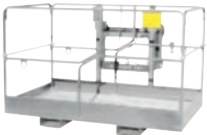
MATERIAL HANDLING		
Rehandling Bucket	4 in 1 Bucket	Construction Bucket
		

PLATFORMS	
Fixed Platform 365 kg	Extensible Platform 1000 kg
	

OTHERS	
Concrete Mixer Bucket	Concrete Bucket
	





Tailor-made finance to make the best use of your funds

You can plan the purchase of your forklift with peace of mind by using MANITOU* financing opportunities.

You will have simple solutions adapted to your needs and seasonal requirements. If you want to make a rapid investment, consider asking us for a personalised proposal to take your situation into account.

* MANITOU Finance solutions are available in certain countries.

MANITOU maintenance contract

2 levels of maintenance adapted to your needs. You are sure of:

- equipment always in good working condition
- a reduction of repair costs as a result of regular servicing
- authentic standardised services

- Labour
- Attendance costs



- Labour
- Attendance costs
- Parts and lubricants



MANIPLUS extension of guarantee

With MANIPLUS you can take out an extension of guarantee of 12 or 24 months.

EASY MANAGER

A simple and flexible system for fleet management (with or without geolocation) to provide optimum service from your machines. EASY MANAGER gives you:

- real-time materials management
- simple and easy way of managing your machinery activity and maintenance.
- maximise your asset and safeguard your equipment



MANITOU spare parts

Utilising genuine MANITOU spare parts is sure to prolong the best performance capability of your machine. Your MANITOU dealer has access to a stock of 70,000 part numbers, available in 24 hours in Europe (48 hours outside Europe).

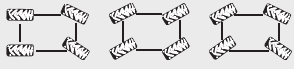

MT 835

	MT 835	MT 835 H
Lifting		
Max. capacity	3500 kg	
Max. lifting height	7.75 m	
Max. outreach	4.45 m	
Break-out force with bucket	6264 daN	
Unladen time		
Lifting	6.6 secs	
Lowering	6.0 secs	
Extension	6.0 secs	
Retraction	5.6 secs	
Crowd	3.2 secs	
Dump	3 secs	
Tyres	400/80-24	
Braking		
Service brake	Oil immersed multi-disc braking on front/rear axles	
Parking brake	Automatic Negative Handbrake	
Engine		
	PERKINS - STAGE 3B	
Type	854E-34TA	
Cubic capacity	3400 cm ³	
Power	102 HP/75 kW	
Max. torque	420 Nm - 1400 rpm	
Injection	direct	
Cooling	water	
Laden drawbar pull	8200 daN	6200 daN
Transmission		
	torque converter 4 wheel drive	hydrostatic 4 wheel drive
Reversing shift	electrohydraulic control	
Number of gears (forward/reverse)	4/4	3/2
Max. travel speed (may vary according to applicable regulations)	26 kph	25 kph
Steering mode	4 wheel steer - 3 Steering Modes	
		
Controls		
	JSM® Joystick multi - function Load Limiter Cut off system - EN15000 Norm	
Hydraulics		
Pump	gear type with priority valve 125 l/min - 270 bar	
Capacities		
Hydraulic oil	175 l	
Fuel	120 l	
Unladen weight (with forks)	7200 kg	7300 kg
Dimensions		
1. Front wheel centre to carriage	1.49 m	
2. Ground clearance	0.41 m	
3. Overall length to carriage	5.24 m	
4. Wheelbase	2.88 m	
5. Rear wheel centre to rear face	0.87 m	
6. Overall width of cab	0.88 m	
7. Inside tyre width	1.87 m	
8. Overall width	2.28 m	
9. Overall height	2.42 m	
Standard forks (length x width x thickness)	1200 x 125 x 45 mm	
Turning radius (over tyres)	3.85 m	
Carriage rotation (crowd/dump)	12° / 114°	
Noise and vibration		
Noise at driving position (LpA)	82 dB	
Environmental noise (LwA)	106 dB	
Vibration to whole hand/arm	<2.5 m/s ²	
Vibration on driver's body	2 m/s ²	

Rough terrain load chart
standard EN1459 annex B

Machine on tyres with forks

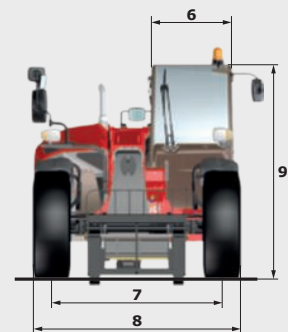
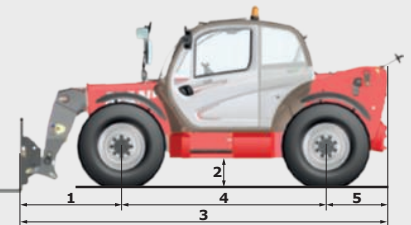
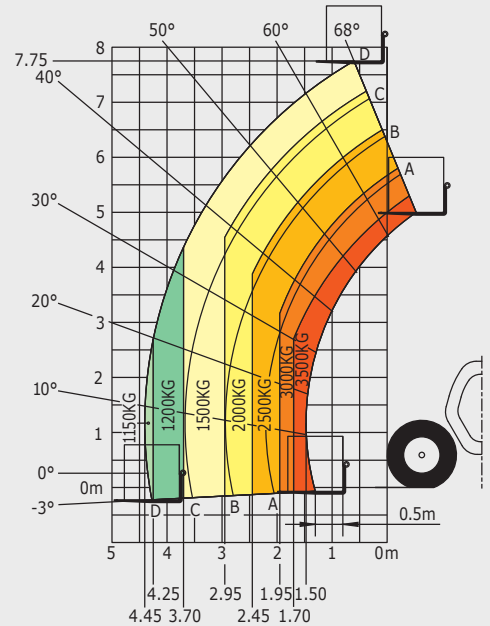

This brochure describes versions and configuration options for Manitou products which may be fitted with different equipment. The equipment described in this brochure may be standard, optional or not available depending on version. Manitou reserves the right to change the specifications shown and described at any time and without prior warning. The manufacturer is not liable for the specifications given. For more information, contact your Manitou dealer. Non-contractual document. Product descriptions may differ from actual products. List of specifications is not comprehensive. The logos and visual identity of the company are the property of Manitou and may not be used without authorisation. All rights reserved. The photos and diagrams contained in this brochure are provided for information only.

MANITOU BP SA - Limited company with board of directors - Share capital: 39,547,824 euros - 857 802 508 RCS Nantes



MT1135

	MT 1135	MT 1135 H	MT 1135 HA
Lifting			
Max. capacity		3500 kg	
Max. lifting height		11.05 m	
Max. outreach		7.75 m	
Break-out force with bucket		6305 daN	
Unladen time			
Lifting		8.5 secs	
Lowering		7.0 secs	
Extension		13.0 secs	
Retraction		9.0 secs	
Crowd		3.0 secs	
Dump		3.0 secs	
Tyres		400/80-24	
Braking			
Service brake	Oil immersed multi-disc braking on front/rear axles		
Parking brake	Automatic Negative Handbrake		
Engine	PERKINS - STAGE 3B		
Type	854E-34TA		
Cubic capacity	3400 cm ³		
Power	102 HP/75 kW		
Max. torque	420 Nm - 1400 rpm		
Injection	direct		
Cooling	water		
Laden drawbar pull	9150 daN		7150 daN
	torque converter 4 wheel drive		hydrostatic 4 wheel drive
Transmission	electrohydraulic control		
Reversing shift			
Number of gears (forward/reverse)	4/4		3/2
Max. travel speed (may vary according to applicable regulations)	26 km/h		25 km/h
Steering mode	4 wheel steer - 3 Steering Modes		
			
Controls	JSM® Joystick multi - function Load Limiter Cut off system - EN15000 Norm		
Hydraulics			
Pump	gear type with priority valve 125 l/min - 270 bar		
Capacities			
Hydraulic oil	175 l		
Fuel	120 l		
Unladen weight (with forks)	8800 kg		8900 kg
Dimensions			
1. Front wheel centre to carriage	1.60 m		
2. Ground clearance	0.41 m		
3. Overall length to carriage	5.37 m		
4. Wheelbase	2.88 m		
5. Rear wheel centre to rear face	0.89 m		
6. Overall width of cab	0.88 m		
7. Inside tyre width	1.87 m		
8. Overall width	2.28 m		
9. Overall width (stabilizers lowered)	2.28 m		
10. Overall height	2.42 m		
Standard forks (length x width x thickness)	1200 x 125 x 45 mm		
Turning radius (over tyres)	3.85 m		
Frame levelling	+/- 10°		
Carriage rotation (crowd/dump)	16°/110°		
Noise and vibration			
Noise at driving position (LpA)	82 dB		
Environmental noise (LwA)	106 dB		
Vibration to whole hand/arm	<2.5 m/s ²		
Vibration on driver's body	2 m/s ²		

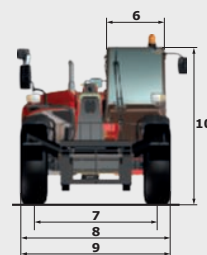
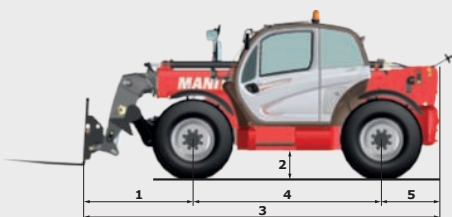

MT1135

Rough terrain load chart standard EN1459 annex B

Machine on tyres with forks

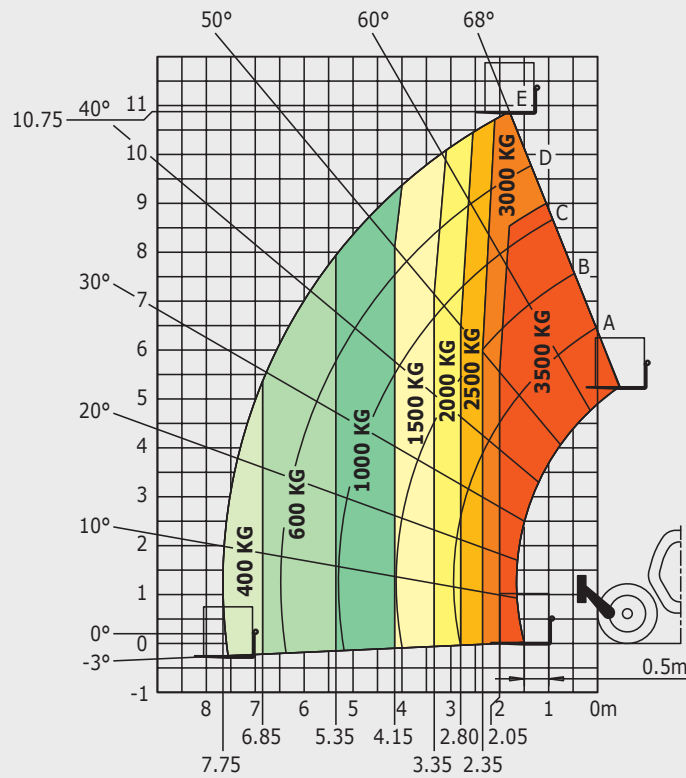

Machine on stabilizers with forks

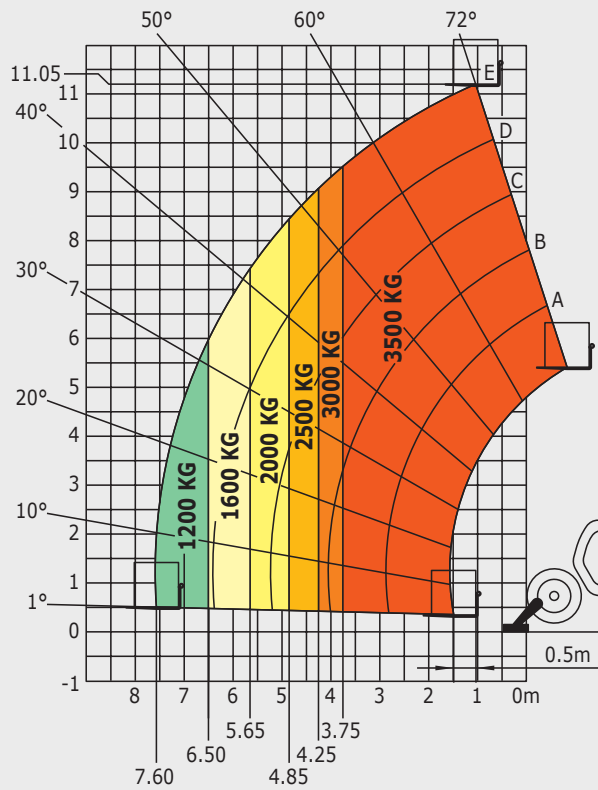

This brochure describes versions and configuration options for Manitou products which may be fitted with different equipment. The equipment described in this brochure may be standard, optional or not available depending on version. Manitou reserves the right to change the specifications shown and described at any time and without prior warning. The manufacturer is not liable for the specifications given. For more information, contact your Manitou dealer. Non-contractual document. Product descriptions may differ from actual products. List of specifications is not comprehensive. The logos and visual identity of the company are the property of Manitou and may not be used without authorisation. All rights reserved. The photos and diagrams contained in this brochure are provided for information only.

MANITOU BF SA - Limited company with board of directors - Share capital: 39,547,824 euros - 857 802 508 RCS Nantes



MT1335

	MT 1335	MT 1335 H	MT 1335 HA
Lifting			
Max. capacity		3500 kg	
Max. lifting height		12.55 m	
Max. outreach		8.75 m	
Break-out force with bucket		6400 daN	
Unladen time			
Lifting		9.8 secs	
Lowering		8.2 secs	
Extension		14.2 secs	
Retraction		9.7 secs	
Crowd		2.7 secs	
Dump		2.8 secs	
Tyres		400/80-24	
Braking			
Service brake		Oil immersed multi-disc braking on front/rear axles	
Parking brake		Automatic Negative Handbrake	
Engine		PERKINS - STAGE 3B	
Type		854E-34TA	
Cubic capacity		3400 cm ³	
Power		102 HP/75 kW	
Max. torque		420 Nm - 1400 rpm	
Injection		direct	
Cooling		water	
Laden drawbar pull	9800 daN		7800 daN
	torque converter 4 wheel drive		hydrostatic 4 wheel drive
Transmission		electrohydraulic control	
Reversing shift			
Number of gears (forward/reverse)	4/4		3/2
Max. travel speed (may vary according to applicable regulations)	26 km/h		25 km/h
Steering mode		4 wheel steer - 3 Steering Modes	
			
Controls		JSM® Joystick multi - function Load Limiter Cut off system - EN15000 Norm	
Hydraulics		gear type with priority valve - 125 l/min - 270 bar	
Pump			
Capacities			
Hydraulic oil		175 l	
Fuel		120 l	
Unladen weight (with forks)	8800 kg		8900 kg
Dimensions			
1. Front wheel centre to carriage		1.80 m	
2. Ground clearance		0.41 m	
3. Overall length to carriage		5.86 m	
4. Wheelbase		2.88 m	
5. Rear wheel centre to rear face		1.18 m	
6. Overall width of cab		0.88 m	
7. Inside tyre width		1.87 m	
8. Overall width		2.28 m	
9. Overall width (stabilizers lowered)		2.28 m	
10. Overall height		2.42 m	
Standard forks (length x width x thickness)		1200 x 125 x 45 mm	
Turning radius (over tyres)		3.85 m	
Frame levelling		+/- 10°	
Carriage rotation (crowd/dump)		12°/114°	
Noise and vibration			
Noise at driving position (LpA)		82 dB	
Environmental noise (LwA)		106 dB	
Vibration to whole hand/arm		<2.5 m/s ²	
Vibration on driver's body		2 m/s ²	

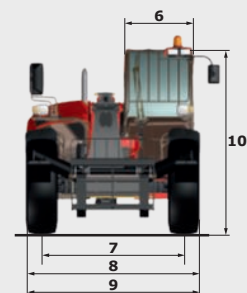
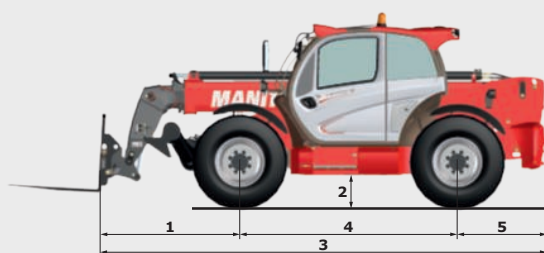

MT1335

Rough terrain load chart

standard EN1459 annex B

Machine on tyres with forks

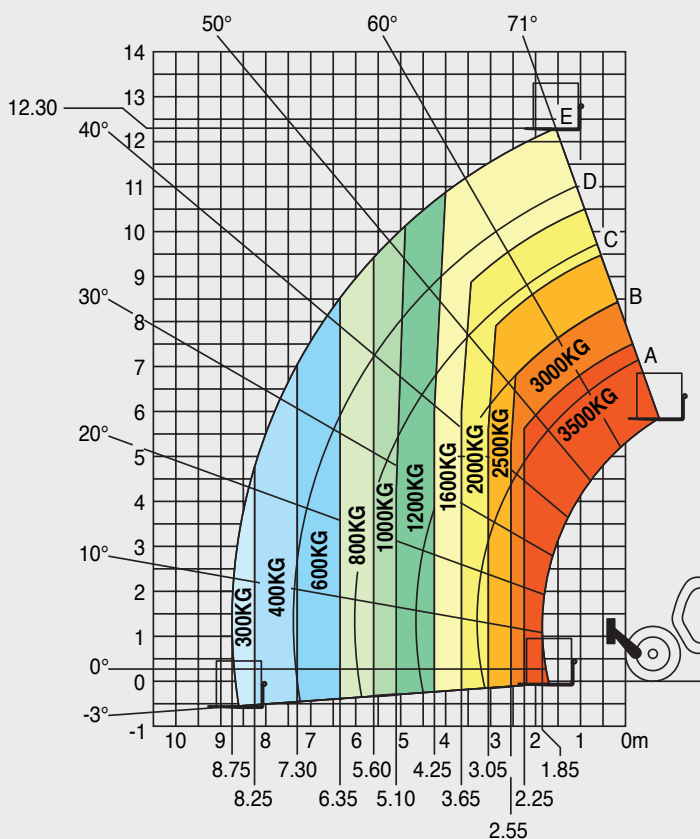

Machine on stabilizers with forks

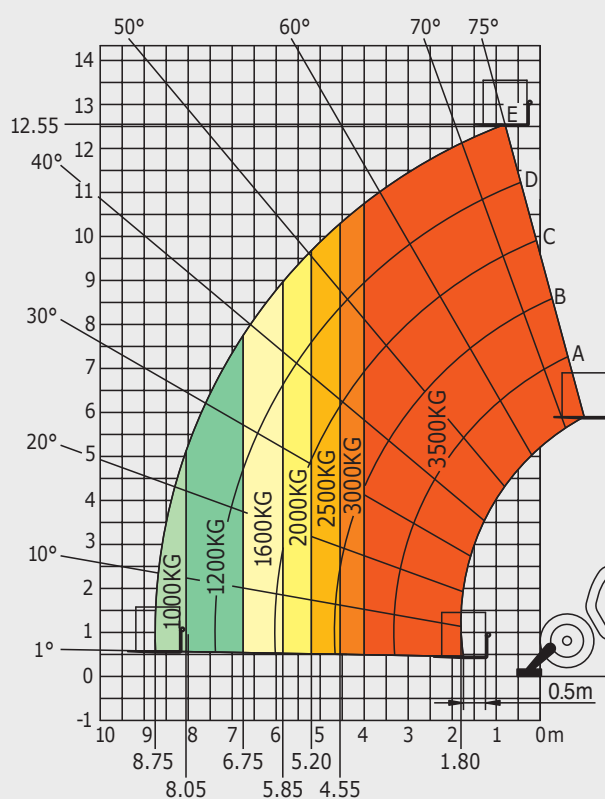

Machine on stabilizers with platform

(MT 1335 HA versions)

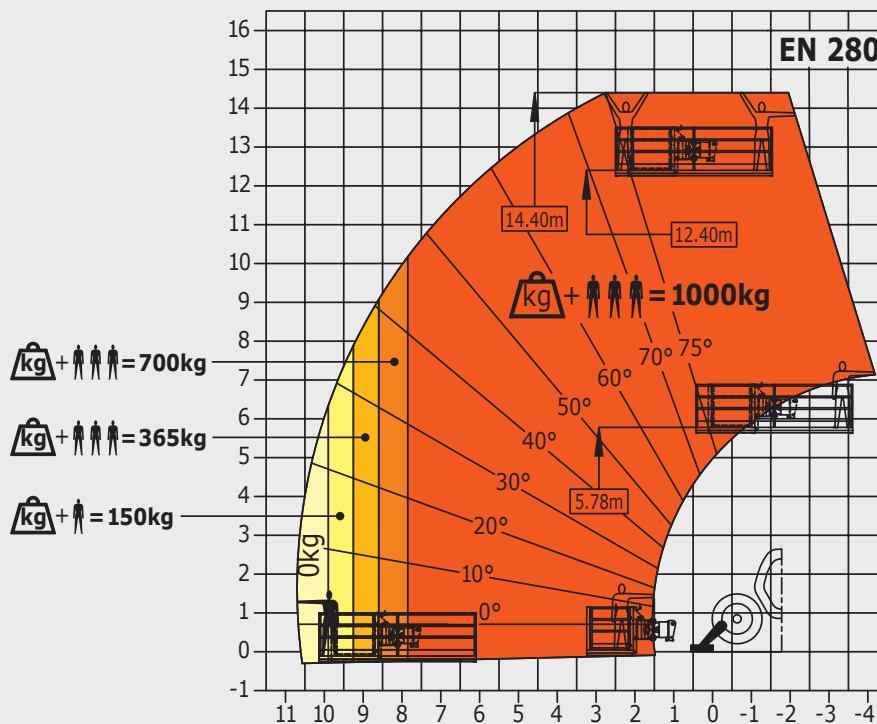

This brochure describes versions and configuration options for Manitou products which may be fitted with different equipment. The equipment described in this brochure may be standard, optional or not available depending on version. Manitou reserves the right to change the specifications shown and described at any time and without prior warning. The manufacturer is not liable for the specifications given. For more information, contact your Manitou dealer. Non-contractual document. Product descriptions may differ from actual products. List of specifications is not comprehensive. The logos and visual identity of the company are the property of Manitou and may not be used without authorisation. All rights reserved. The photos and diagrams contained in this brochure are provided for information only.

MANITOU BF SA - Limited company with board of directors - Share capital: 39,547,824 euros - 857 802 508 RCS Nantes



Your nearest **MANITOU** dealer:



Head office:
B.P. 249 - 430 rue de l'Aubinière - 44158 Ancenis Cedex - France
Tel: 00 33 (0)2 40 09 10 11 - Fax: 00 33 (0)2 40 09 10 97
www.manitou.com